

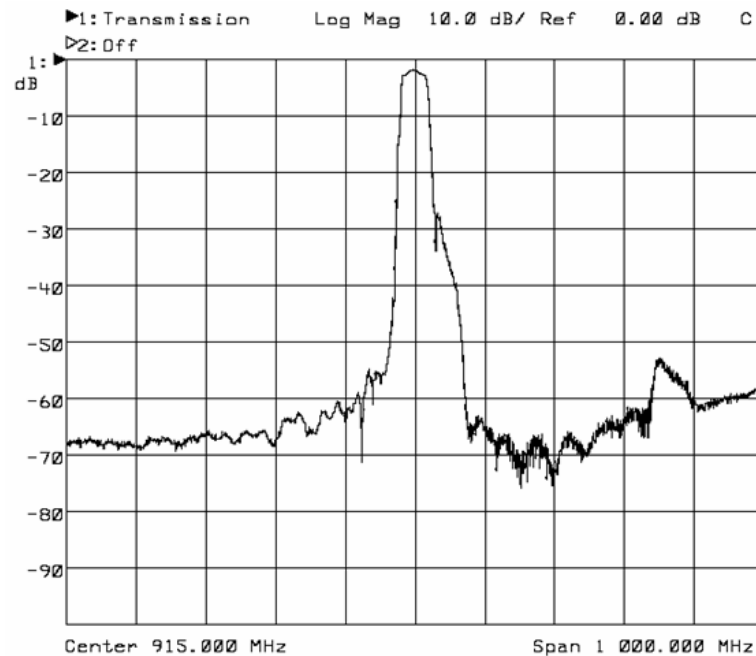

## DESCRIPTION

- 915 MHz SAW bandpass filter with 26 MHz bandwidth.
- 3 x 3 mm ceramic LCC package.
- RoHS compliant.

## TYPICAL PERFORMANCE

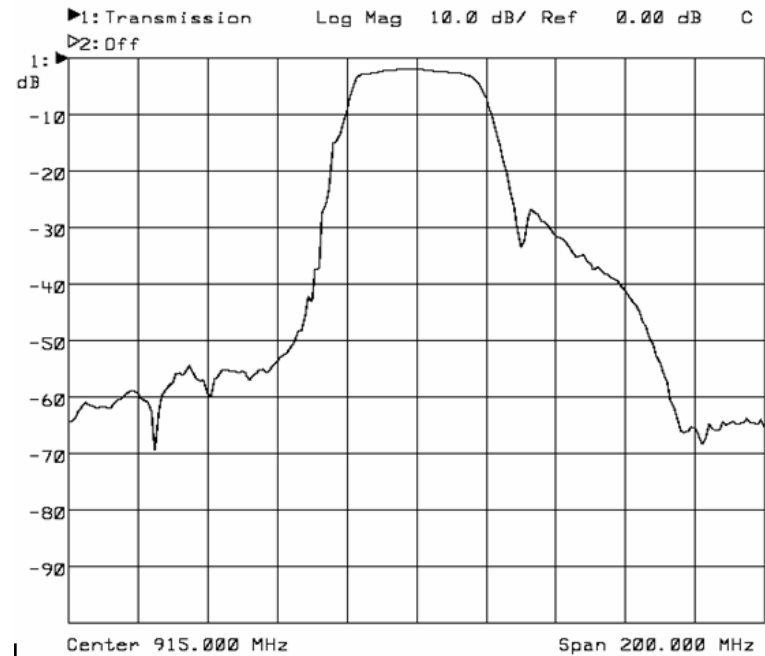



## SPECIFICATION

Parameter	Min	Typ	Max	Units
Center Frequency ( $F_c$ ) <sup>1</sup>	-	915.0	-	MHz
Bandwidth (3dB)	26	34	-	MHz
Insertion Loss <sup>2</sup>	-	2.8	3.3	dB
Passband Amplitude Ripple <sup>2</sup>	-	1.1	1.5	dB
Stopband Rejection, 10-800 MHz	50	55	-	dB
Stopband Rejection, 800-845 MHz	45	50	-	dB
Stopband Rejection, 845-880 MHz	35	40	-	dB
Stopband Rejection, 947-992 MHz	15	18	-	dB
Stopband Rejection, 992-1020 MHz	35	40	-	dB
Stopband Rejection, 1020-1200 MHz	45	50	-	dB
Temperature Coefficient of Frequency	-30			ppm/°K
Source and Load Impedance	50			$\Omega$ //0nF

- Notes:
1. Fixed reference point.
  2. Evaluated over 902 to 928 MHz.

## MAXIMUM RATINGS

Parameter	Min	Max	Units
Storage Temperature Range	-40	85	°C
Operating Temperature Range	-10	70	°C
Input Power Level	-	10	dBm
DC Voltage	-	10	Volts

## MATCHING CIRCUIT

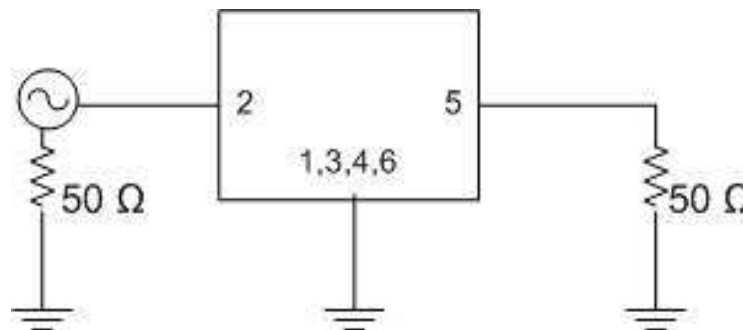

Notes:

1. Matching components are not required; 50 ohm single-ended system.

**PACKAGE OUTLINE**

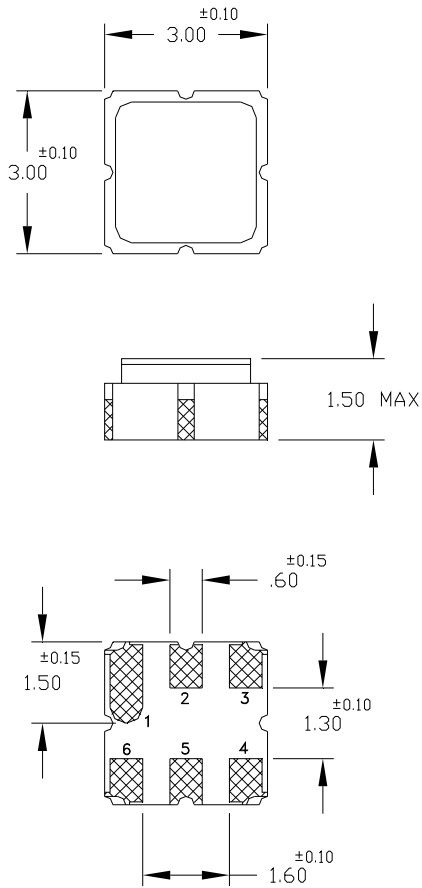

**SUGGESTED FOOTPRINT**

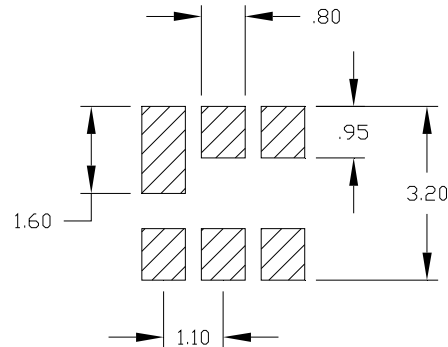

**Units:** mm

Typical tolerances are ±0.15 mm except where indicated.

**Pad Configuration:**

Input: 2  
 Output: 5  
 Ground: 1,3,4,6

Package Material:  
 Body: Al<sub>2</sub>O<sub>3</sub> ceramic  
 Lid: Kovar, Ni plated  
 Terminations: Au plating 1 μm min, over a 1.3-8.9 μm Ni plating

**MARKING**

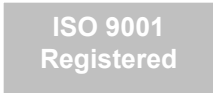
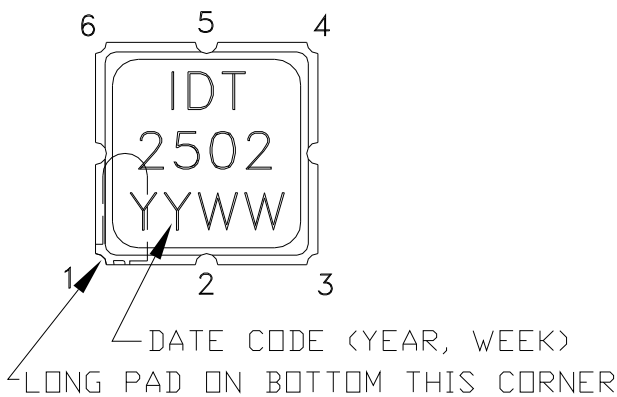

All specifications are believed to be accurate and reliable. However, MNC reserves the right to make changes without notice.  
 © 2006 All rights reserved.